

# GaN Amplifier 50 V, 30 W AVG 3.3 - 3.8 GHz



**MACOM PURE CARBIDE™**

**MAPC-A2517**  
Rev. V1

## Features

- MACOM PURE CARBIDE® Amplifier Series
- Optimized for Cellular Base Station Applications
- Designed for Digital Predistortion Error Correction Systems
- Optimized for Asymmetrical Doherty Application
- High Terminal Impedances for Broadband Performance
- 50 V Operation
- 100% RF Tested
- RoHS\* Compliant

## Description

The MAPC-A2517 is a high power GaN on Silicon Carbide HEMT D-mode amplifier suitable for asymmetrical Doherty base station applications with 30W average power and optimized for 3.3 - 3.8 GHz modulated signal operation. The device supports pulsed, and linear operation with peak output power levels to 250 W (54.0 dBm) in an air cavity ceramic package.

## Typical Doherty Performance:

- 3.3-3.7 GHz Evaluation Board
- WCDMA 3GPP TM1, 10 dB PAR @ 0.01% CCDF.  
 $V_{DS} = 48\text{ V}$ ,  $I_{DQCAR} = 300\text{ mA}$ ,  $V_{GSPK} = -4.38\text{ V}$ ,  
 $T_{CASE} = 25^\circ\text{C}$ ,  $P_{OUT} = 44.7\text{ dBm}$

Frequency (GHz)	GP (dB)	$\eta_D$ (%)	Output PAR (dB)	ACPR (dBc)
3.3	14.2	45.5	8.3	-27.2
3.5	15.7	45.0	8.0	-33.0
3.7	15.3	47.0	8.0	-30.3

- 3.4-3.8 GHz Evaluation Board
- WCDMA 3GPP TM1, 10 dB PAR @ 0.01% CCDF.  
 $V_{DS} = 48\text{ V}$ ,  $I_{DQCAR} = 300\text{ mA}$ ,  $V_{GSPK} = -4.38\text{ V}$ ,  
 $T_{CASE} = 25^\circ\text{C}$ ,  $P_{OUT} = 44.7\text{ dBm}$

Frequency (GHz)	GP (dB)	$\eta_D$ (%)	Output PAR (dB)	ACPR (dBc)
3.4	15.3	44.5	8.3	-28.9
3.6	15.8	47.9	7.9	-31.5
3.8	14.7	44.2	8.6	-32.3

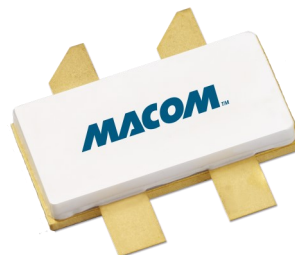

AC-780S-4

## Functional Schematic

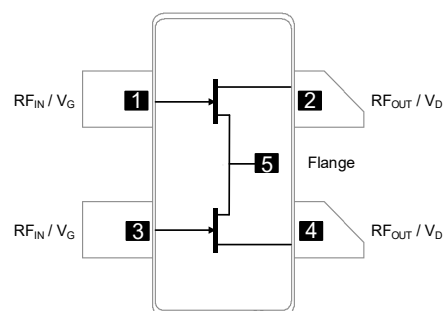

## Pin Configuration

Pin No.	Pin Name	Function
1	RF <sub>IN</sub> / V <sub>G</sub>	RF Input / Gate (Carrier)
2	RF <sub>OUT</sub> / V <sub>D</sub>	RF Output / Drain (Carrier)
3	RF <sub>IN</sub> / V <sub>G</sub>	RF Input / Gate (Peaking)
4	RF <sub>OUT</sub> / V <sub>D</sub>	RF Output / Drain (Peaking)
5	Flange <sup>1</sup>	Ground / Source

1. The flange on the package bottom must be connected to RF, DC and thermal ground.

## Ordering Information

Part Number	Package
MAPC-A2517-AS000	Bulk Quantity
MAPC-A2517-ASTR1	Tape and Reel
MAPC-A2517-ASSB1	Sample Board

<sup>1</sup> \* Restrictions on Hazardous Substances, compliant to current RoHS EU directive.

# GaN Amplifier 50 V, 30 W AVG

## 3.3 - 3.8 GHz



**MACOM PURE CARBIDE™**

**MAPC-A2517**  
Rev. V1

**RF Electrical Specifications:  $T_C = 25^\circ\text{C}$ ,  $V_{DS} = 48\text{ V}$ ,  $I_{DQCAR} = 300\text{ mA}$ ,  $V_{GSPK} = -4.38\text{ V}$**   
**Note: Performance in MACOM Doherty Evaluation Test Fixture, 50 Ohm system.**

Parameter	Test Conditions	Symbol	Min.	Typ.	Max.	Units
Small Signal Gain	Pulsed <sup>2</sup> , 3.6 GHz	$G_{SS}$	-	17.7	-	dB
Saturated Output Power	Pulsed <sup>2</sup> , 3.6 GHz	$P_{SAT}$	-	52.2	-	dBm
Drain Efficiency at Saturation	Pulsed <sup>2</sup> , 3.6 GHz	$\eta_{SAT}$	-	52.0	-	%
AM/PM	Pulsed <sup>2</sup> , 3.6 GHz	$\Phi$	-	5	-	°
Modulated Peak Power	WCDMA <sup>3</sup> , 3.6 GHz	$P_{-2.5dB}^4$	-	52.6	-	dBm
VBW Resonance Point	IMD 3rd Order Inflection Point	$VBW_{RES}$	-	300	-	MHz
Gain Flatness in 400 MHz	WCDMA <sup>3</sup> , $P_{OUT} = 44.7\text{ dBm}$	$G_F$	-	1.0	-	dB
Gain Variation (-25°C to +105°C)	WCDMA <sup>3</sup> , 3.6 GHz, $P_{OUT} = 44.7\text{ dBm}$	$\Delta G$	-	0.02	-	dB/°C
Power Variation (-25°C to +105°C)	Pulsed <sup>2</sup> , 3.6 GHz	$\Delta P_{-1dB}$	-	0.017	-	dB/°C
Power Gain	WCDMA <sup>3</sup> , 3.6 GHz, $P_{OUT} = 44.7\text{ dBm}$	$G_P$	-	15.8	-	dB
Drain Efficiency	WCDMA <sup>3</sup> , 3.6 GHz, $P_{OUT} = 44.7\text{ dBm}$	$\eta$	-	48.0	-	%
Output PAR @ 0.01% CCDF	WCDMA <sup>3</sup> , 3.6 GHz, $P_{OUT} = 44.7\text{ dBm}$	PAR	-	7.9	-	dB
Adjacent Channel Power Ratio	WCDMA <sup>3</sup> , 3.6 GHz, $P_{OUT} = 44.7\text{ dBm}$	ACPR	-	-34.5	-	dBc
Input Return Loss	WCDMA <sup>3</sup> , 3.6 GHz, $P_{OUT} = 44.7\text{ dBm}$	IRL	-	-15	-	dB
Ruggedness: Output Mismatch	All phase angles	$\Psi$	VSWR = 10:1, No Device Damage			

**RF Electrical Specifications:  $T_A = 25^\circ\text{C}$ ,  $V_{DS} = 50\text{ V}$ ,  $I_{DQCAR} = 300\text{ mA}$ ,  $V_{GSPK} = -4.3\text{ V}$**   
**Note: Performance in MACOM Doherty Production Test Fixture, 50  $\Omega$  system**

Parameter	Test Conditions	Symbol	Min.	Typ.	Max.	Units
Power Gain	WCDMA <sup>3</sup> , 3.55 GHz, $P_{OUT} = 44.7\text{ dBm}$	$G_P$	14.0	15.0	-	dB
Drain Efficiency	WCDMA <sup>3</sup> , 3.55 GHz, $P_{OUT} = 44.7\text{ dBm}$	$\eta$	38.4	43.2	-	%
Output PAR @ 0.01% CCDF	WCDMA <sup>3</sup> , 3.55 GHz, $P_{OUT} = 44.7\text{ dBm}$	PAR	7.3	7.7	-	dB
Input Return Loss	WCDMA <sup>3</sup> , 3.55 GHz, $P_{OUT} = 44.7\text{ dBm}$	IRL	-	-14	-6	dB

2. Pulse details: 100  $\mu\text{s}$  pulse width, 10% Duty Cycle.

3. Modulated Signal: 3.84 MHz, WCDMA 3 GPP TM1 64 DPCH, 9.9 dB PAR @ 0.01% CCDF.

4.  $P_{2.5dB} = P_{OUT} + 7.5\text{ dB}$  where  $P_{OUT}$  is the average output power measured using a modulated signal<sup>3</sup> where the output PAR is compressed to 7.5 dB @ 0.01% probability CCDF.

**DC Electrical Characteristics  $T_A = 25^\circ\text{C}$**

Parameter	Test Conditions	Symbol	Min.	Typ.	Max.	Units
Carrier Amplifier						
Drain-Source Breakdown Voltage (Carrier)	$V_{GS} = -8\text{ V}, V_{DS} = 130\text{ V}$	$V_{BDS}$	130	-	-	V
Gate-Source Leakage Current (Carrier)	$V_{GS} = -8\text{ V}, V_{DS} = 0\text{ V}$	$I_{GLK}$	-	0.008	-	mA
Gate-Source Leakage Current (Carrier)	$V_{GS} = -8\text{ V}, V_{DS} = 50\text{ V}$	$I_{GLK}$	-	-	0.90	mA
Gate Threshold Voltage	$V_{DS} = 50\text{ V}, I_D = 10.56\text{ mA}$	$V_T$	-4.0	-3.1	-	V
Gate Quiescent Voltage	$V_{DS} = 50\text{ V}, I_D = 130\text{ mA}$	$V_{GSQ}$	-3.1	-2.8	-2.1	V
On Resistance (Carrier)	$V_{GS} = 2\text{ V}, I_D = 85\text{ mA}$	$R_{ON}$	-	0.34	-	$\Omega$
Maximum Drain Current	$V_{DS} = 7\text{ V}$ pulsed, pulse width 300 $\mu\text{s}$	$I_{D, MAX}$	-	6.0	-	A
Peaking Amplifier						
Drain-Source Breakdown Voltage (Peaking)	$V_{GS} = -8\text{ V}, V_{DS} = 130\text{ V}$	$V_{BDS}$	130	-	-	V
Gate-Source Leakage Current (Peaking)	$V_{GS} = -8\text{ V}, V_{DS} = 0\text{ V}$	$I_{GLK}$	-	0.016	-	mA
Gate-Source Leakage Current (Peaking)	$V_{GS} = -8\text{ V}, V_{DS} = 50\text{ V}$	$I_{GLK}$	-	-	1.79	mA
Gate Threshold Voltage	$V_{DS} = 50\text{ V}, I_D = 21.12\text{ mA}$	$V_T$	-4.0	-3.1	-	V
Gate Quiescent Voltage	$V_{DS} = 50\text{ V}, I_D = 250\text{ mA}$	$V_{GSQ}$	-3.1	-2.8	-2.1	V
On Resistance (Peaking)	$V_{GS} = 2\text{ V}, I_D = 170\text{ mA}$	$R_{ON}$	-	0.17	-	$\Omega$
Maximum Drain Current	$V_{DS} = 7\text{ V}$ pulsed, pulse width 300 $\mu\text{s}$	$I_{D, MAX}$	-	12.0	-	A

**Absolute Maximum Ratings<sup>5,6,7,8,9</sup>**

Parameter	Absolute Maximum
Drain Source Voltage, $V_{DS}$	200 V
Gate Source Voltage, $V_{GS}$	-15 to 3 V
Gate Current (Carrier), $I_G$	10.6 mA
Gate Current (Peaking), $I_G$	21.1 mA
Storage Temperature Range	-65°C to +150°C
Case Operating Temperature Range	-40°C to +120°C
Channel Operating Temperature Range, $T_{CH}$	-40°C to +225°C
Absolute Maximum Channel Temperature	+250°C

5. Exceeding any one or combination of these limits may cause permanent damage to this device.
6. MACOM does not recommend sustained operation above maximum operating conditions.
7. Operating at drain source voltage  $V_{DS} < 55$  V will ensure  $MTTF > 2.51 \times 10^6$  hours.
8. Operating at nominal conditions with  $T_{CH} \leq 225^\circ\text{C}$  will ensure  $MTTF > 2.51 \times 10^6$  hours.
9. MTTF may be estimated by the expression  $MTTF \text{ (hours)} = A e^{[B + C/(T+273)]}$  where  $T$  is the channel temperature in degrees Celsius.,  $A = 1.93$ ,  $B = -45.31$ , and  $C = 29,585$ .

**Thermal Characteristics<sup>10</sup>**

Parameter	Test Conditions	Symbol	Typical	Units
Thermal Resistance using Finite Element Analysis	$V_{DS} = 50$ V $T_C=85^\circ\text{C}, T_{CH} = 225^\circ\text{C}$	$R_{\theta}(\text{FEA})$	2.3	°C/W
Thermal Resistance using Infrared Measurement of Die Surface Temperature	$V_{DS} = 50$ V $T_C=85^\circ\text{C}, T_{CH} = 225^\circ\text{C}$	$R_{\theta}(\text{IR})$	1.84	°C/W

10. Case temperature measured using thermocouple embedded in heat-sink. Contact local applications support team for more details on this measurement.

**Handling Procedures**

Please observe the following precautions to avoid damage:

**Static Sensitivity**

Gallium Nitride Circuits are sensitive to electrostatic discharge (ESD) and can be damaged by static electricity. Proper ESD control techniques should be used when handling these devices.

Pulsed<sup>2</sup> Load-Pull Performance: Reference Plane at Device Leads

Frequency (GHz)	Z <sub>SOURCE</sub> (Ω)	Carrier Amplifier: Maximum Output Power					
		V <sub>DS</sub> = 50 V, I <sub>DQ</sub> = 130 mA, T <sub>C</sub> = 25°C, P2.5dB					
		Z <sub>LOAD</sub> <sup>11</sup> (Ω)	Gain (dB)	P <sub>OUT</sub> (dBm)	P <sub>OUT</sub> (W)	η <sub>D</sub> (%)	AM/PM (°)
3.3	8.5 - j22.8	8.9 - j5.3	17.9	49.6	91.2	57.7	1.3
3.4	18.8 - j23.6	9.2 - j5.0	17.9	49.6	91.2	57.9	-0.1
3.6	18.3 - j1.6	9.5 - j4.2	17.3	49.5	89.1	56.7	-0.5
3.8	6.9 - j5.9	9.8 - j3.2	16.3	49.4	87.1	55.7	3.6

Frequency (GHz)	Z <sub>SOURCE</sub> (Ω)	Carrier Amplifier: Maximum Drain Efficiency					
		V <sub>DS</sub> = 50 V, I <sub>DQ</sub> = 130 mA, T <sub>C</sub> = 25°C, P2.5dB					
		Z <sub>LOAD</sub> <sup>12</sup> (Ω)	Gain (dB)	P <sub>OUT</sub> (dBm)	P <sub>OUT</sub> (W)	η <sub>D</sub> (%)	AM/PM (°)
3.3	9.3 - j25.1	4.5 - j9.2	20.6	47.9	61.7	69.5	-3.6
3.4	25.5 - j23.6	4.9 - j9.7	20.5	47.8	60.3	70.3	-14.0
3.6	13.2 + j0.7	6.6 - j11.1	19.5	47.8	60.3	68.1	-8.2
3.8	5.2 - j7.0	10.0 - j11.7	17.7	47.9	61.7	65.5	1.7

Frequency (GHz)	Z <sub>SOURCE</sub> (Ω)	Peaking Amplifier: Maximum Output Power					
		V <sub>DS</sub> = 50 V, I <sub>DQ</sub> = 250 mA, T <sub>C</sub> = 25°C, P2.5dB					
		Z <sub>LOAD</sub> <sup>11</sup> (Ω)	Gain (dB)	P <sub>OUT</sub> (dBm)	P <sub>OUT</sub> (W)	η <sub>D</sub> (%)	AM/PM (°)
3.3	3.9 - j13.0	5.5 - j7.1	18.3	52.9	195.0	53.8	0.3
3.4	4.6 - j15.0	5.6 - j6.8	18.4	52.9	195.0	54.3	0.4
3.6	7.0 - j19.0	5.8 - j5.9	17.7	52.6	182.0	51.6	-0.5
3.8	13.0 - j12.0	5.6 - j5.5	17.0	52.4	173.8	51.2	0.8

Frequency (GHz)	Z <sub>SOURCE</sub> (Ω)	Peaking Amplifier: Maximum Drain Efficiency					
		V <sub>DS</sub> = 50 V, I <sub>DQ</sub> = 250 mA, T <sub>C</sub> = 25°C, P2.5dB					
		Z <sub>LOAD</sub> <sup>12</sup> (Ω)	Gain (dB)	P <sub>OUT</sub> (dBm)	P <sub>OUT</sub> (W)	η <sub>D</sub> (%)	AM/PM (°)
3.3	3.9 - j13.0	2.4 - j9.2	20.1	51.2	131.8	64.0	-4.9
3.4	4.6 - j15.0	2.9 - j8.7	21.1	51.3	134.9	64.4	-5.1
3.6	7.0 - j19.0	3.9 - j9.3	20.2	51.3	134.9	61.4	-9.6
3.8	13.0 - j12.0	5.4 - j9.8	19.0	51.2	131.8	56.2	-11.0

Impedance Reference

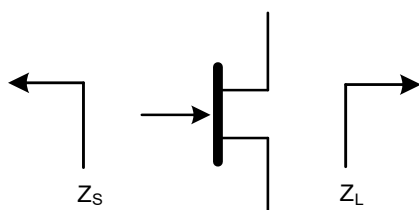

Z<sub>SOURCE</sub> = Measured impedance presented to the input of the device at package reference plane.  
Z<sub>LOAD</sub> = Measured impedance presented to the output of the device at package reference plane.

- 11. Load Impedance for optimum output power.
- 12. Load Impedance for optimum efficiency.

**Pulsed<sup>2</sup> Load-Pull Performance: Carrier Amplifier 3.6 GHz**

**P2.5dB Loadpull Output Power Contours (dBm)**

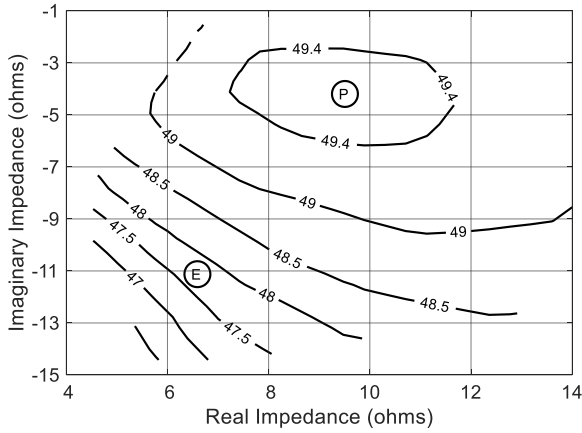

**P2.5dB Loadpull Drain Efficiency Contours (%)**

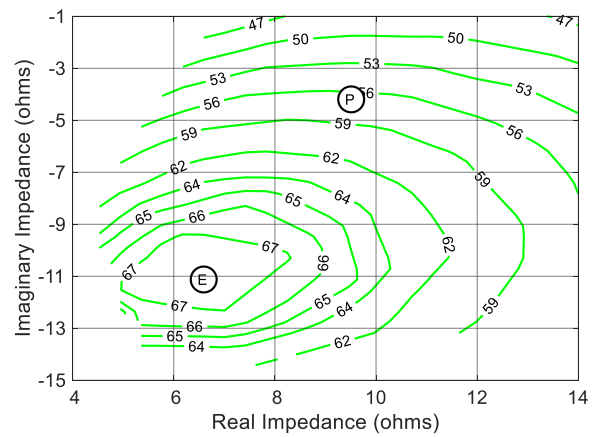

**P2.5dB Loadpull Gain Contours (dB)**

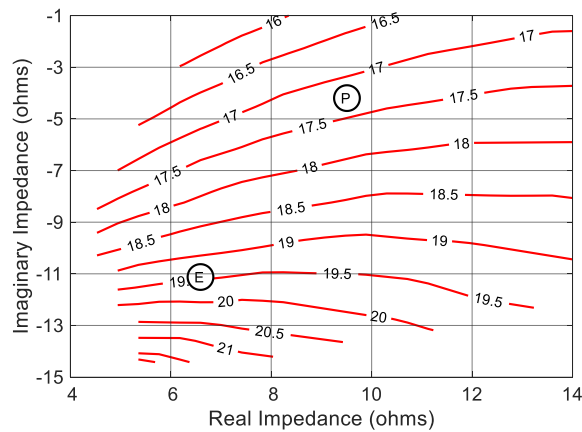

**P2.5dB Loadpull AM/PM Contours (°)**

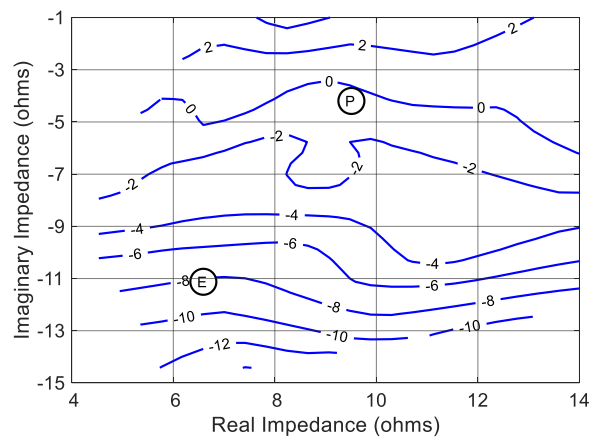

**Gain vs. Output Power**

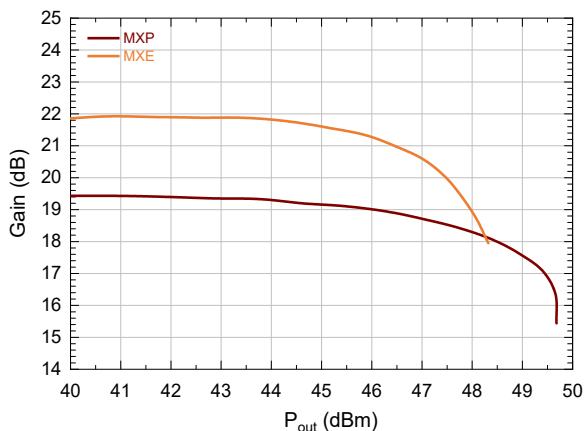

**Drain Efficiency vs. Output Power**

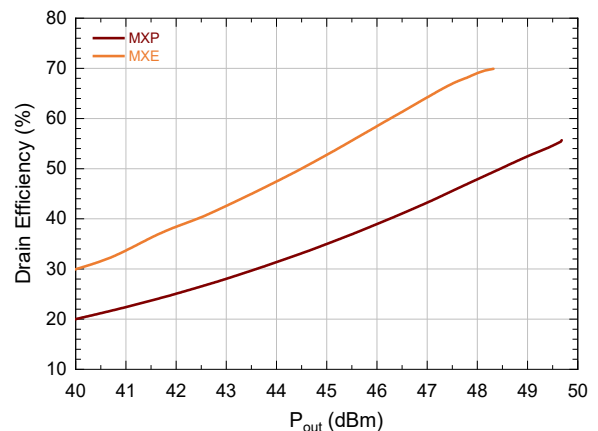

Pulsed<sup>2</sup> Load-Pull Performance: Peaking Amplifier 3.6 GHz

P2.5dB Loadpull Output Power Contours (dBm)

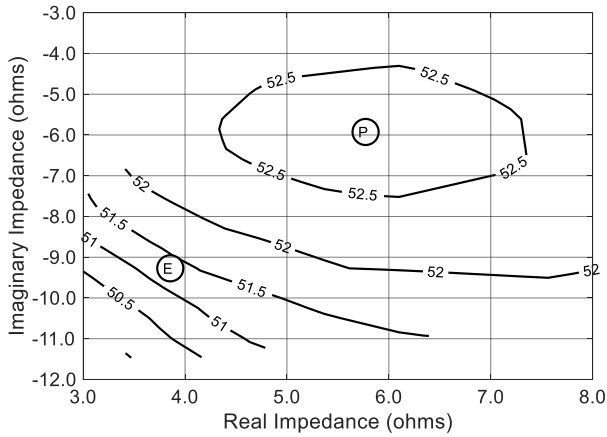

P2.5dB Loadpull Drain Efficiency Contours (%)

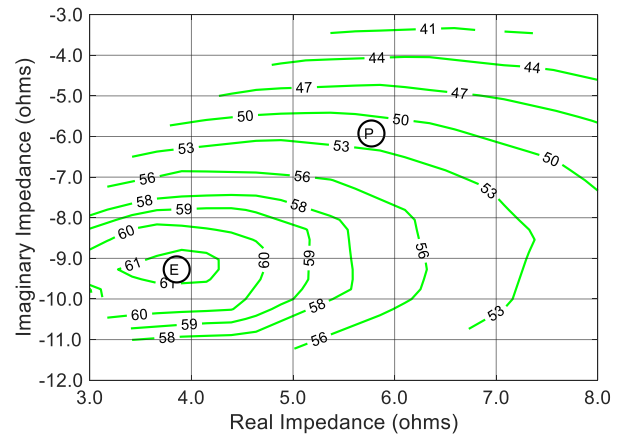

P2.5dB Loadpull Gain Contours (dB)

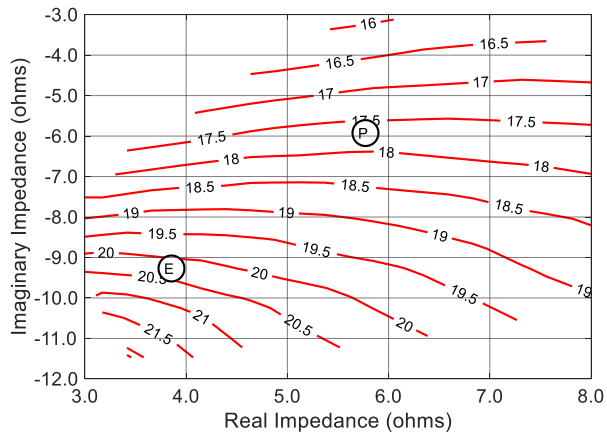

P2.5dB Loadpull AM/PM Contours (°)

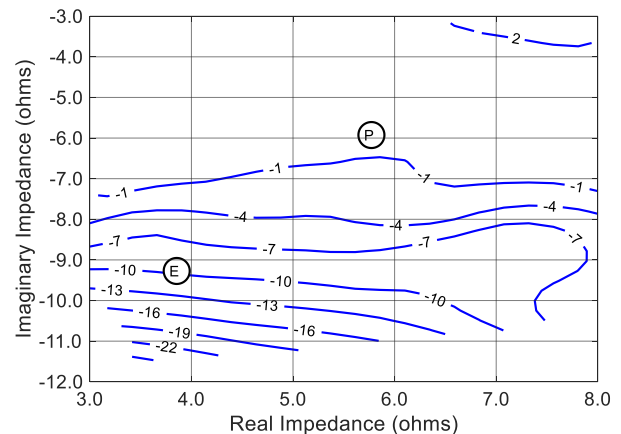

Gain vs. Output Power

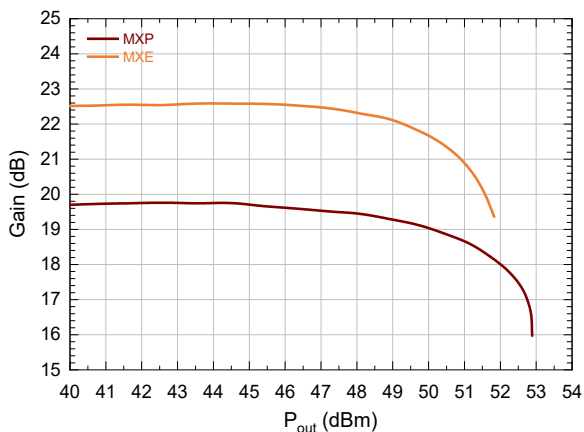

Drain Efficiency vs. Output Power

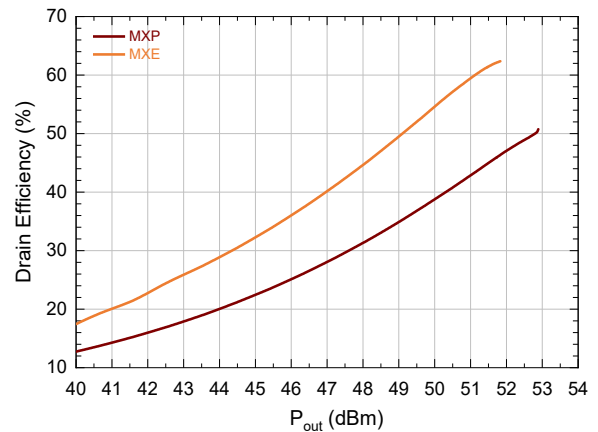

Lead-Free AC-780S-4 Package Dimensions<sup>†</sup>

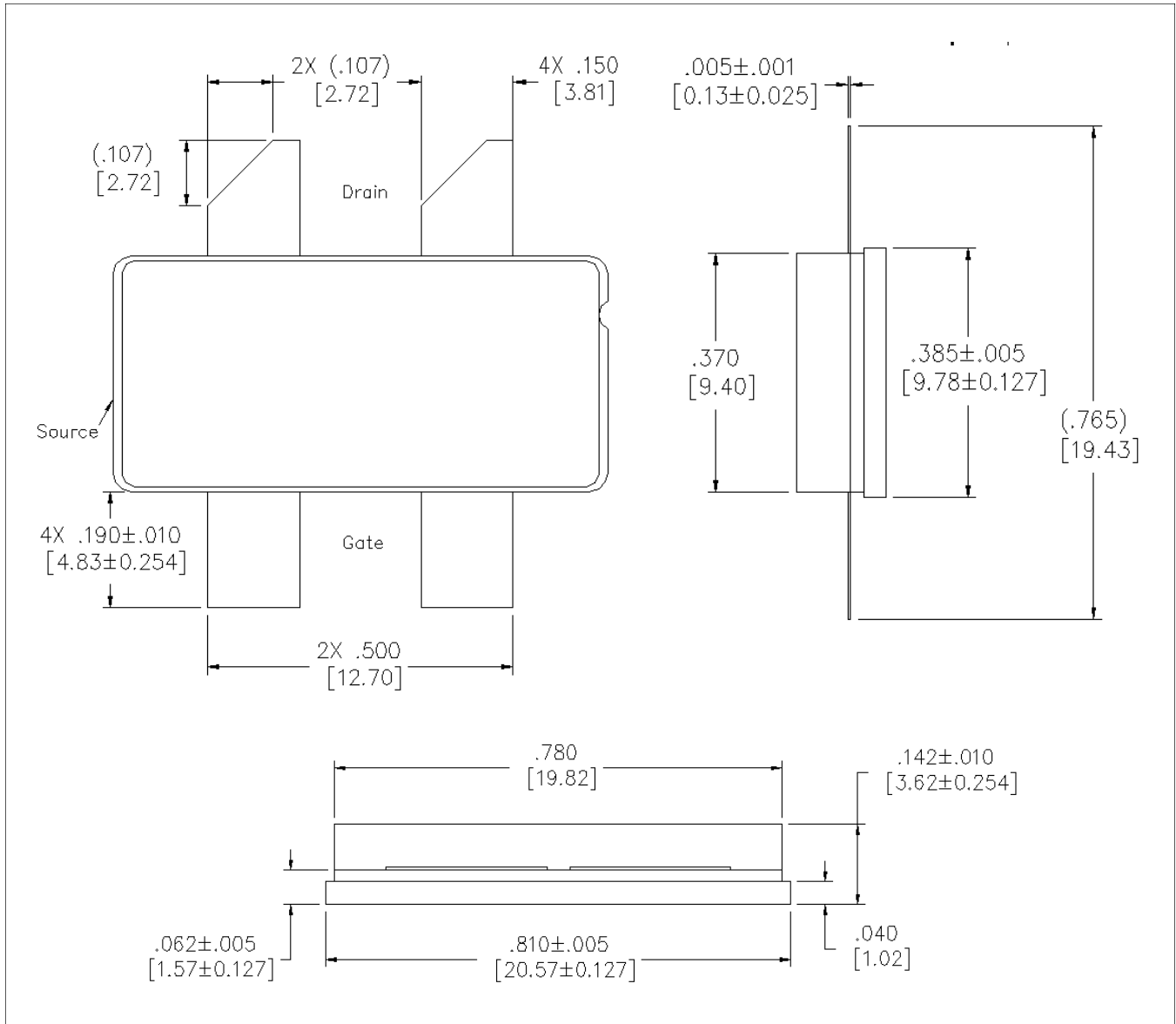

<sup>†</sup> Reference Application Note AN0004363 for lead-free solder reflow recommendations.  
Meets JEDEC moisture sensitivity level 3 requirements.  
Plating is Au.



MACOM Technology Solutions Inc. ("MACOM"). All rights reserved.

These materials are provided in connection with MACOM's products as a service to its customers and may be used for informational purposes only. Except as provided in its Terms and Conditions of Sale or any separate agreement, MACOM assumes no liability or responsibility whatsoever, including for (i) errors or omissions in these materials; (ii) failure to update these materials; or (iii) conflicts or incompatibilities arising from future changes to specifications and product descriptions, which MACOM may make at any time, without notice. These materials grant no license, express or implied, to any intellectual property rights.

THESE MATERIALS ARE PROVIDED "AS IS" WITH NO WARRANTY OR LIABILITY, EXPRESS OR IMPLIED, RELATING TO SALE AND/OR USE OF MACOM PRODUCTS INCLUDING FITNESS FOR A PARTICULAR PURPOSE, MERCHANTABILITY, INFRINGEMENT OF INTELLECTUAL PROPERTY RIGHT, ACCURACY OR COMPLETENESS, OR SPECIAL, INDIRECT, INCIDENTAL, OR CONSEQUENTIAL DAMAGES WHICH MAY RESULT FROM USE OF THESE MATERIALS.

MACOM products are not intended for use in medical, lifesaving or life sustaining applications. MACOM customers using or selling MACOM products for use in such applications do so at their own risk and agree to fully indemnify MACOM for any damages resulting from such improper use or sale.